

OPTIKA[®]
M I C R O S C O P E S
I T A L Y

B-810 & B-1000



Research Lab Upright Microscopes

② B-810/B-1000 - Research Lab Upright Microscopes



B-810/B-1000 - Research Lab Upright Microscopes

2

Laboratory

OPTIKA Microscopes, thanks to the long experience achieved in microscopy development, has conceived the new B-1000: a major leap in our technological offer. As a flagship instrument, B-1000 originates from customer most demanding feedbacks and needs. Its modularity and versatility will allow to find the perfect place in any clinical or basic research laboratory. All controls are easily accessible and comfortable also for extended periods of observation.

B-1000 is built on IOS Infinity Corrected optical system, which gives both top-notch optical performances, and the possibility to extend your instrument with the broad range of accessories and modules. X-LED illumination is the best solution to have pure white light, very intense even at higher magnification, and optimum power efficiency given by solid state source.

If you are looking for our best solution to your present and future professional demands, B-1000 is the answer.



Highest category of optical equipment among our product range guarantees a sharp and clear view in any situation, while top level mechanical design offers sturdiness and long lifetime.



B-810/B-1000 - Research Lab Upright Microscopes

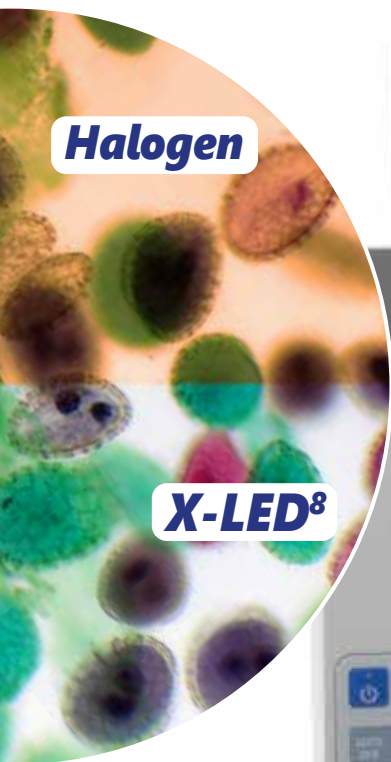

Halogen

X-LED⁸

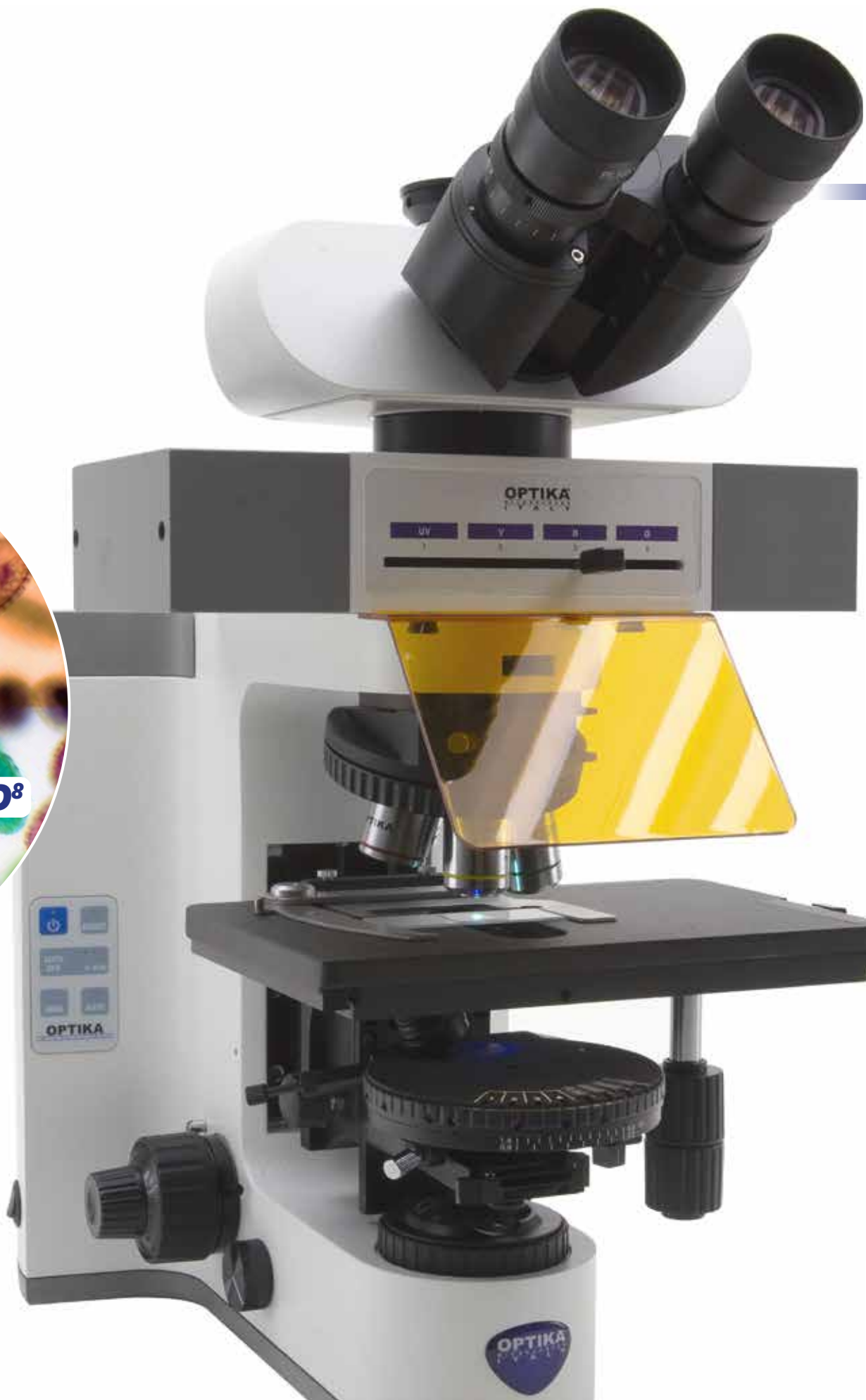

B-810/B-1000 - Research Lab Upright Microscopes

2

Laboratory

Solid Stand – Extra Stability

A completely new design and a die-cast aluminum stand offer solidity and durability, even for the most demanding laboratory use.

This new microscope can seamlessly be upgraded with many attachments that extend its field of use.

X-LED White Illumination

X-LED illumination system is based on a pure white high-efficiency LED and a special optics. It guarantees constant color temperature, no heat, and an extreme electrical consumption efficiency. The whole system is pre-aligned and boasts a lifetime of 50,000 hours.

X-LED benefits

Powerful pure white LED illumination, ideal for brightfield, darkfield and phase contrast applications. Constant color temperature through all the intensity levels. No heat generation, avoiding damage of the specimen. Factory pre-centering assures uniform illumination over the field of view, yet providing perfect Koehler alignment. Very long lifetime and high power efficiency.

Light under control

Intelligent control of the microscope illumination: the "AUTO-OFF" function automatically switches the light off after a user-selectable time period. "BOOST" gives an extra high level of illumination for light-demanding applications. "AUTO" allows to store an illumination level, and to maintain it throughout the inspection.

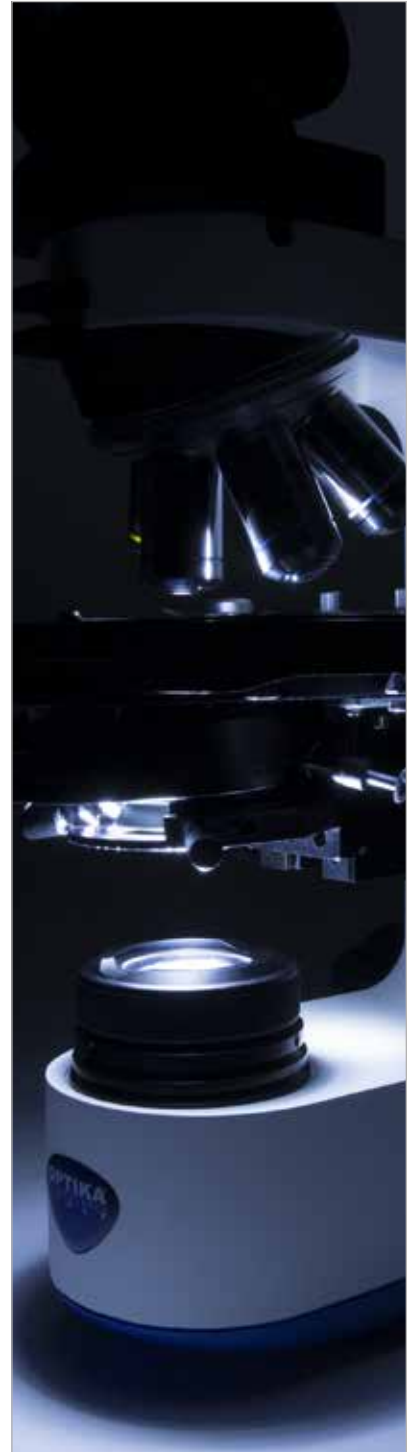

Ergonomy

Low position focus and stage controls allow a fast and comfortable operation. Frequently used controls as light intensity adjustment and diaphragm are also placed in the lower part of the stand and enable operation without having to take the eyes off the specimen. All optical heads are equipped with high-point eyepieces and dioptic adjustment, for the best viewing experience.

B-810/B-1000 - Research Lab Upright Microscopes



Modularity – Build your own solution

Many worlds in one instrument. Modularity allows to build the desired solution (brightfield, darkfield, phase contrast, material science, fluorescence, motorized automation and so on). B-1000 has the flexibility to help your work the best way.

Comfortable Stage

Refined belt-driven stage, with a wide working surface and a highly precise XY movement.

High Quality IOS Optical System

Infinity corrected optical system, based on planachromatic, fluorite and semi-apochromatic objectives, designed to give sharp and clear images, both for the user and the digital camera. Quintuple and sextuple nosepieces give the flexibility to build the objectives that best suits your needs. The system is completed with wide field, high-point eyepieces, with a field number of 24mm.

Ready for Digital Imaging

Range of adapters can accommodate for C-mount digital cameras, as well as reflex cameras. Focus adjustment gives perfectly clear digital images. Our cameras include specific software for capturing, measuring, marking and storing your images. Pro View software allows to perform image acquisition, post-processing, measurements and storage of your images. User can save a preset for later work, or even create a multi-focus composition.



B-810/B-1000 - Research Lab Upright Microscopes

2

Laboratory

Remote-controlled microscope

The stage can be remote-controlled through a dedicated software: X, Y, Z axes, as well as nosepiece, can be moved with a single click. Communication protocol is available for interfacing with custom software, such as automated analysis or autofocus.



X-Y-Z motorized stage
Motorized nosepiece



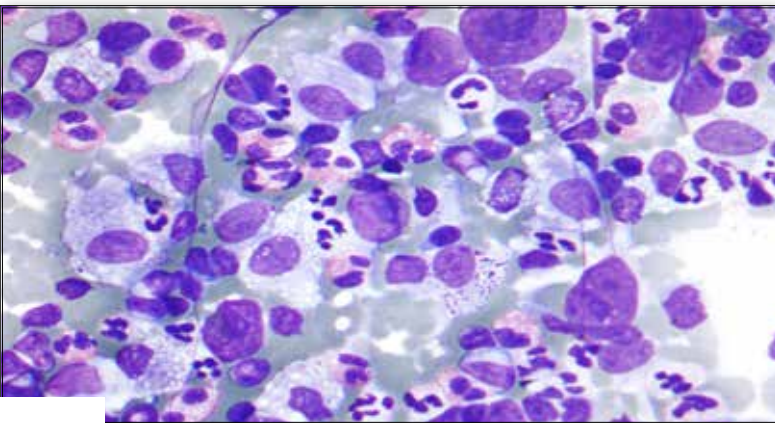

Pathology / Cytology

Since B-810 / B-1000 use white LED illumination, they can maintain the same color temperature even if the brightness is changed. "AUTO" function automatically adjusts the light intensity when the objective is changed or the aperture diaphragm is set to a different value.

These features, along with motorized stage and ergonomic controls, make your workflow easier.

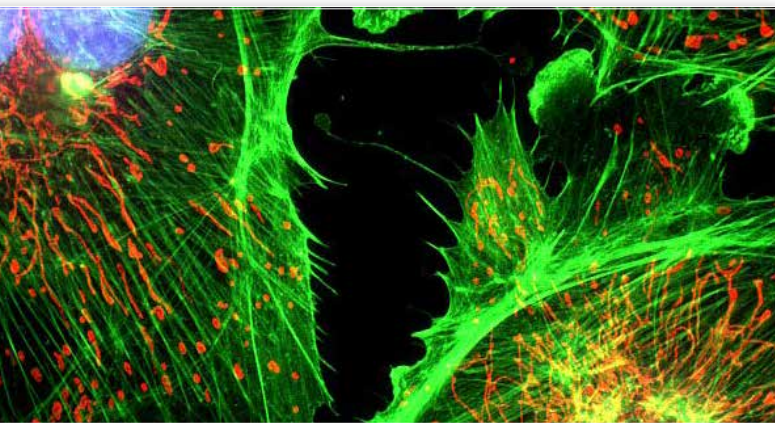

Fluorescence Microscopy

A new attachment for epi-fluorescence provides the ultimate solution in the field of fluorescence diagnostic. Vibration-free six positions filter wheel with shutter, field and aperture diaphragms offer all you need for a complete analysis. Custom filtersets are available and mounted on request. For application where efficiency, rapidity and ease of use are crucial, this model offers also a LED epi-fluorescence attachment, with very high power standard illuminators.



Phase Contrast Microscopy

The bright LED illuminator brings a comfortable view in phase contrast with all magnifications. Universal wheel condenser allows to quickly switch between brightfield, darkfield and phase contrast.

Ideal for clinical laboratories or fibers (e.g. asbestos) analysis.

Darkfield Microscopy

Ideal for observing blood cells, diatoms, small insects, bone, fibers, unstained bacteria, yeast, protozoa, mineral and chemical crystals, colloidal particles, dust-count specimens, and thin sections of polymers and ceramics.

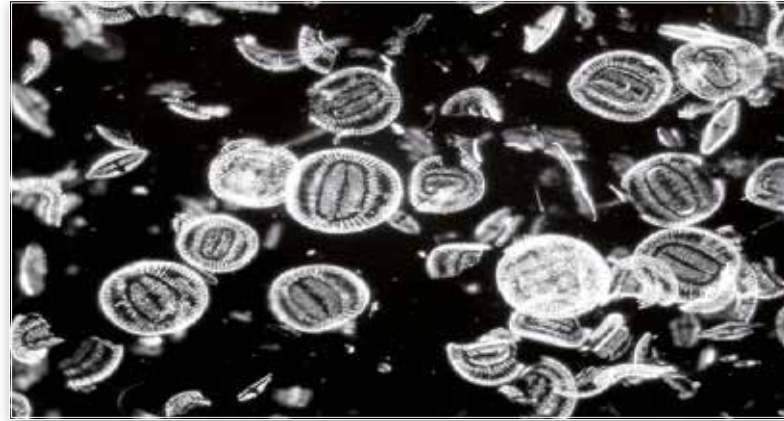

Material Science

A new attachment designed specifically for metallographic inspection, with dedicated objectives set, for the most complete epi-illumination analysis: brightfield, darkfield and polarizing view observations.

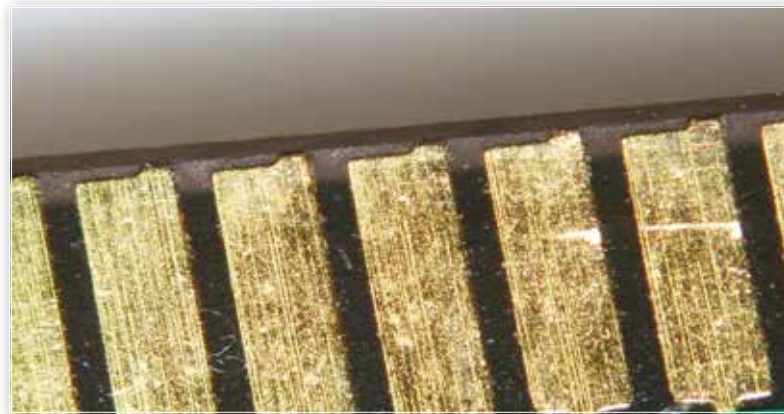

Polarizing Microscopy

Polarized light microscopy is used in geological applications or also for both natural and industrial minerals, composites such as concretes, ceramics, mineral fibers and polymers, and crystalline or biological molecules such as DNA, starch, wood and urea.

Attachments for a full polarization analysis are available (both for transmitted and incident light), so it's possible to look at color fringes right away.

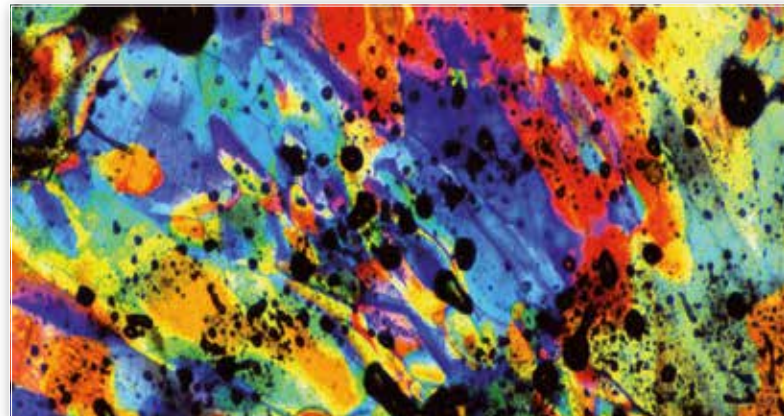

B-810/B-1000 - Design and Production

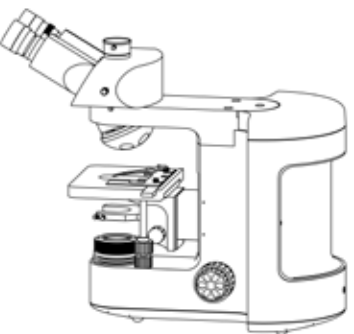
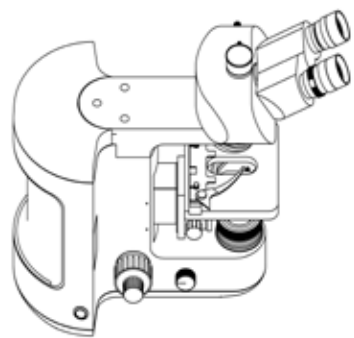
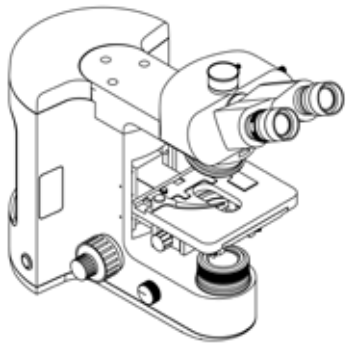
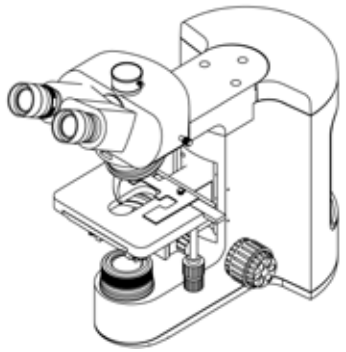

B-810/B-1000 - Design and Production

OPTIKA workshop provides the facilities for precise and reliable optomechanical manufacturing, essential for this kind of instruments.

CNC machining department, equipped with 5-axis milling machine and lathe.



Die-cast stands ready to be processed.



Work in progress inside the milling machine.



Microscope stands exiting from the internal varnishing facility.



All processes are carefully monitored through the application of **ISO 9001 Quality System standards.**

② B-810/B-1000 - Components

Eyepieces

Laboratory



M-1001

PL10x/22 eyepieces (pair), high eyepoint, with rubber cup (retractable)



M-1002

PL10x/24 eyepieces (pair), high eyepoint, with rubber cup (retractable); for B-1000 only



M-1003

PL15x/16 eyepieces (pair), high eyepoint



M-781

PL10x/22 eyepiece, high eyepoint, with micrometric scale (10mm/100um) & rubber cup (retractable)



AA-01

12.5x/18 eyepieces (pair), high eyepoint, with dioptic adjustment, one with W&B graticule for Asbestos



M-1004.N

Centering telescope



Heads



M-1010

Trinocular head, two positions (100/0, 50/50) for B-1000



M-1011

Trinocular head, three positions (100/0, 50/50, 0/100) for B-1000



M-1012

Binocular ERGO head for B-1000



M-1013

Trinocular ERGO head, two positions (100/0, 50/50) for B-1000



M-1188

Trinocular head, single position (50/50) for B-810



② B-810/B-1000 - Components

Bodies



M-1187

Main body with focus system and X-LED³ illumination for B-810



M-1021B

Main body with focus system and X-LED⁸ illumination, for general purposes for B-1000



M-1021M

Main body with focus system and X-LED⁸ illumination, for metallurgical model for B-1000



M-1022M

Main body with focus system, for metallurgical model with incident light only; for B-1000



M-1156

Upgrade (controller) for any kind of motorization (stage, Z-axis, nosepiece, or all of them together); for B-1000

M-1149

Motorization of Z-axis for B-1000

Nosepieces



M-1040

Quintuple reversed nosepiece, for RMS objectives; for B-810



M-1041

Sextuple reversed nosepiece, for RMS objectives; for B-810



M-1042

Sextuple reversed nosepiece, for RMS objectives with DIC slot; for B-1000



M-1043

Sextuple motorized reversed nosepiece, for RMS objectives with DIC slot; for B-1000



M-1044

Quintuple reversed nosepiece, with centrable positions for POL objectives; for B-1000



M-1045

Quintuple reversed nosepiece for darkfield MET objectives, with 3 adapter rings for RMS objectives; for B-1000



M-1046

Quintuple motorized reversed nosepiece for darkfield MET objectives, with 3 adapter rings for RMS objectives; for B-1000



② B-810/B-1000 - Components

W-PLAN Objectives

Laboratory



Plan Objectives - IOS W-PLAN Series

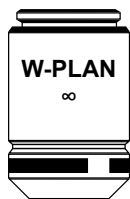

- M-1049** IOS W-PLAN 2x/0.08
- M-1125** IOS W-PLAN 4x/0.10
- M-1126** IOS W-PLAN 10x/0.25
- M-1127** IOS W-PLAN 20x/0.40
- M-1128** IOS W-PLAN 40x/0.65
- M-1129** IOS W-PLAN 60x/0.80
- M-1130** IOS W-PLAN objective 100x/1.25 (oil)
- M-1130.1** IOS W-PLAN objective 100x/1.25 (Iris)

Plan Objectives - IOS W-PLAN PH Series

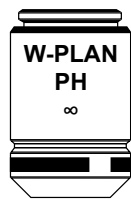

- M-1120.N** IOS W-PLAN PH 10x/0.25
- M-1121.N** IOS W-PLAN PH 20x/0.40
- M-1122.N** IOS W-PLAN PH 40x/0.65
- M-1123.N** IOS W-PLAN PH 100x/1.25 (oil)

Plan Semi-APO Objectives - IOS W-PLAN F Series



- M-1060** IOS W-PLAN F 4x/0.13
- M-1061** IOS W-PLAN F 10x/0.30
- M-1062** IOS W-PLAN F 20x/0.50
- M-1063** IOS W-PLAN F 40x/0.75
- M-1064** IOS W-PLAN F 100x/1.30 (oil)

Plan Objectives - IOS U-PLAN POL Series



- M-1080** IOS U-PLAN POL 4x/0.10
- M-1081** IOS U-PLAN POL 10x/0.25
- M-1081.5** IOS U-PLAN POL 20x/0.45
- M-1082** IOS U-PLAN POL 40x/0.65
- M-1083** IOS U-PLAN POL 60x/0.85

Plan Objectives - IOS LWD W-PLAN MET Series



- M-1099** IOS LWD W-PLAN MET 2.5x/0.08 (with depolarizer)

Plan Objectives - IOS LWD W-PLAN MET BD Series



- M-1109** IOS LWD W-PLAN MET BD 5x/0.12
- M-1110** IOS LWD W-PLAN MET BD 10x/0.25
- M-1111** IOS LWD W-PLAN MET BD 20x/0.40
- M-1112** IOS LWD W-PLAN MET BD 40x/0.60
- M-1113** IOS LWD W-PLAN MET BD 50x/0.75
- M-1114** IOS LWD W-PLAN MET BD 100x/0.80 (dry)

U-PLAN Objectives



Plan Semi-APO Objectives - **IOS U-PLAN F Series**

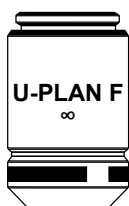

- M-1075** IOS U-PLAN F 4x/0.13
- M-1076** IOS U-PLAN F 10x/0.30
- M-1077** IOS U-PLAN F 20x/0.50
- M-1078** IOS U-PLAN F 40x/0.75
- M-1079** IOS U-PLAN F 100x/1.30 (oil)

Plan APO Objectives - **IOS U-PLAN APO Series**



- M-1301** IOS U-PLAN APO 2x/0.08
- M-1302** IOS U-PLAN APO 4x/0.13
- M-1303** IOS U-PLAN APO 10x/0.40
- M-1304** IOS U-PLAN APO 20x/0.75
- M-1305** IOS U-PLAN APO 40x/0.95
- M-1306** IOS U-PLAN APO 60x/0.90
- M-1307** IOS U-PLAN APO 100x/1.35

Plan Semi-APO Objectives - **IOS U-PLAN F PH Series**

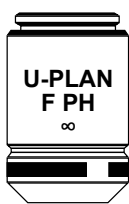

- M-1310** IOS U-PLAN F PH 4x/0.13
- M-1311** IOS U-PLAN F PH 10x/0.40
- M-1312** IOS U-PLAN F PH 20x/0.75
- M-1313** IOS U-PLAN F PH 40x/0.95
- M-1314** IOS U-PLAN F PH 60x/0.90
- M-1315** IOS U-PLAN F PH 100x/1.35

M-1157 universal condenser required

Plan Objectives - **IOS LWD U-PLAN POL Series**

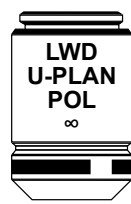

- M-1090** IOS LWD U-PLAN POL 5x/0.15
- M-1091** IOS LWD U-PLAN POL 10x/0.30
- M-1092** IOS LWD U-PLAN POL 20x/0.45
- M-1093** IOS LWD U-PLAN POL 50x/0.55

Plan Objectives - **IOS LWD U-PLAN MET Series**



- M-1100** IOS LWD U-PLAN MET 5x/0.15
- M-1101** IOS LWD U-PLAN MET 10x/0.30
- M-1102** IOS LWD U-PLAN MET 20x/0.45
- M-1103** IOS LWD U-PLAN MET 50x/0.55
- M-1104** IOS LWD U-PLAN MET 100x/0.80 (dry)

Plan Semi-APO Objectives - **IOS LWD U-PLAN F MET Series**



- M-1171** IOS LWD U-PLAN F MET 5x/0.15
- M-1172** IOS LWD U-PLAN F MET 10x/0.30
- M-1173** IOS LWD U-PLAN F MET 20x/0.50
- M-1174** IOS LWD U-PLAN F MET 50x/0.80
- M-1175** IOS LWD U-PLAN F MET 100x/0.90 (dry)

Plan Objectives - **IOS LWD U-PLAN MET BD (Darkfield) Series**

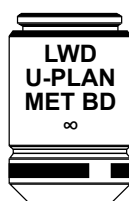

- M-1094** IOS LWD U-PLAN MET BD 5x/0.15
- M-1095** IOS LWD U-PLAN MET BD 10x/0.30
- M-1096** IOS LWD U-PLAN MET BD 20x/0.45
- M-1097** IOS LWD U-PLAN MET BD 50x/0.55
- M-1098** IOS LWD U-PLAN MET BD 100x/0.80 (dry)

Plan Semi-APO Objectives - **IOS LWD U-PLAN F MET BD Series**

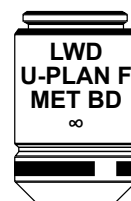

- M-1180** IOS LWD U-PLAN F MET BD 5x/0.15
- M-1181** IOS LWD U-PLAN F MET BD 10x/0.30
- M-1182** IOS LWD U-PLAN F MET BD 20x/0.50
- M-1183** IOS LWD U-PLAN F MET BD 50x/0.80
- M-1184** IOS LWD U-PLAN F MET BD 100x/0.90 (dry)

② B-810/B-1000 - Components

Stages



M-1140
Standard mechanical stage;
175x145mm for B-1000



M-1141
Rackless mechanical stage; movement
knobs with friction adjustment control;
242x157mm; for B-1000.



M-1143
MPC (Mineral Solid Surface)
rackless mechanical stage; movement
knobs with friction adjustment control;
242x157mm; for B-1000.



M-1148
Metallurgical stage with glass, for
metallurgical model; 175x145mm; for
B-1000



M-1190
Rackless mechanical stage;
220x149mm; for B-810



M-1143.1
MPC (Mineral Solid Surface) rackless
mechanical stage; 220x149mm; for
B-810



Stages



M-1145 + M-1146

Rotating Stage, centrable + attachable XY stage; dia. 172mm; for B-1000



M-1147

Motorized mechanical stage; 242x157mm; for B-1000

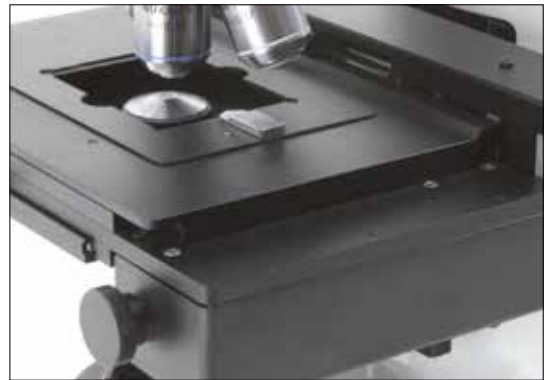

M-1144

Heating stage, with digital temperature controller; 175x145mm; for B-1000

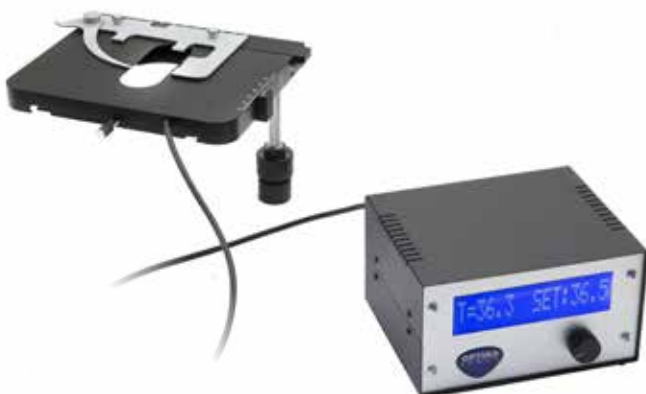

M-1190H

Heating stage, with digital temperature controller; 220x149mm; for B-810



② B-810/B-1000 - Components

Condensers



M-1189

0.90 N.A. swing-out condenser for B-810



M-1150

0.90 N.A. swing-out condenser for B-1000



M-1191

1.2 N.A. swing-out condenser for B-810



M-1151

1.2 N.A. swing-out condenser for B-1000



M-1155

0.9/0.25 N.A. swing-out condenser (to be used with objective M-1049) for B-1000



M-1154

0.70 N.A. swing-out MET condenser for B-1000



Condensers

M-1157 8-Position universal condenser for B-1000



Parts for the universal condenser M-1157

- M-1205** Top lens 0.2 N.A.
- M-1206** Top lens 0.9 N.A.
- M-1207** Top lens 1.4 N.A.
- M-1208** DIC 10x prism
- M-1209** DIC 20x prism
- M-1210** DIC 40x/60x prism
- M-1212** 10x/20x phase ring
- M-1213** 40x/60x phase ring
- M-1214** 100x phase ring
- M-1215** 4x phase ring
- M-1216** Darkfield stop (dry)
- M-1217** Darkfield stop (oil)

M-1153
0.90 N.A. swing-out POL
condenser for B-1000



M-618
Darkfield condenser for dry
objectives for B-1000



M-185
Darkfield condenser for dry
objectives for B-810



M-1124.NO
Phase contrast condenser
with insert slide
10x/20x-40x for B-810



M-1124
Phase contrast condenser
with insert slide
10x/20x-40x for B-1000



M-1152.NO
Phase contrast condenser
10x, 20x, 40x, 100x, BF, DF
for B-810



M-1152.N
Phase contrast condenser
10x, 20x, 40x, 100x, BF, DF
for B-1000



② B-810/B-1000 - Components

Attachments

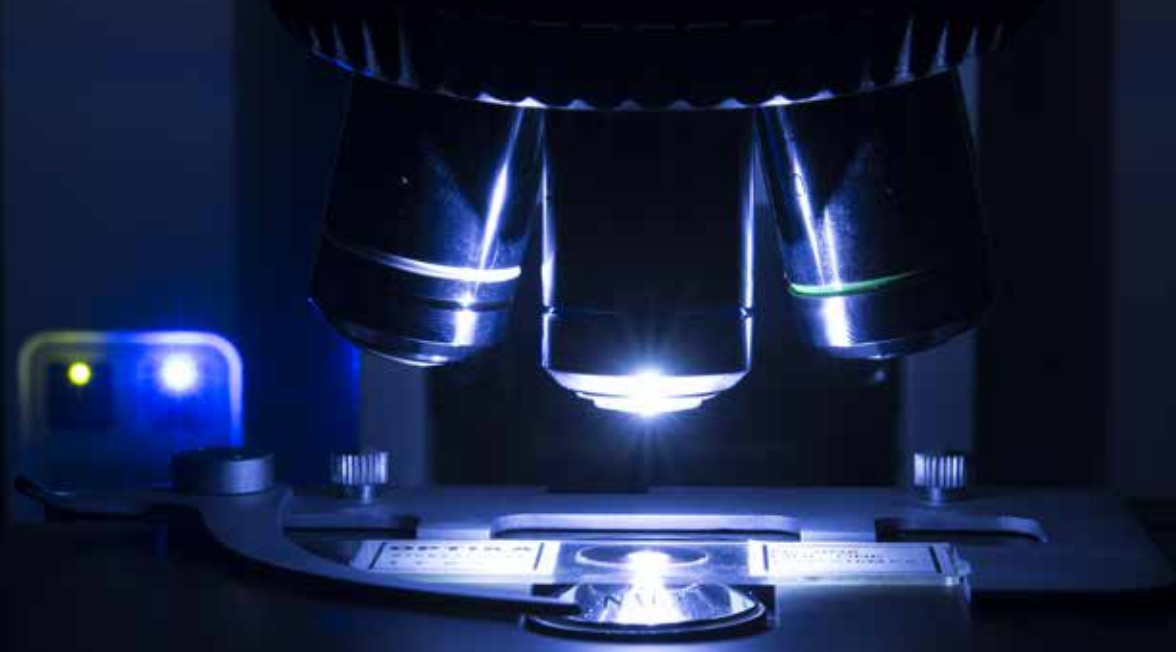

Fluorescence attachments

M-1031M

4-position LED Fluorescence attachment. Without LED-Filtersets (see B-1000 4FLD page for choice); for B-1000



M-1032

6-position HBO Fluorescence attachment, with standard Blue and Green filtersets (FITC & TRITC). With Aperture & Field Diaphragms; for B-1000.



Polarizing attachments

M-1033

Bertrand lens with analyzer and slot for sliders (with Lambda, 1/4 Lambda and Quartz Edge); for B-1000



M-1034

8W X-LED incident polarizing attachment. With Aperture & Field Diaphragms; for B-1000



ALC attachments

M-1030

Automatic Light Control (ALC) system for B-1000



Attachments



Metallurgical attachment

M-1035

Metallurgical attachment, 100 W Halogen. Equipped with Polarizer and rotating Analyzer. With Aperture & Field Diaphragms. 2 empty slots for extra filters; for B-1000.

**M-1036**

Metallurgical attachment, 100 W Halogen. Equipped with Polarizer and rotating Analyzer. With Aperture & Field Diaphragms. 2 empty slots for extra filters; for B-1000.



B-810/B-1000 - Components

Discussion Bridges for B-1000



M-1163



M-1159



M-1160



M-1161



M-1162

M-1159
Discussion Bridge with 1 extra head.
Face-to-Face type

M-1160
Discussion Bridge with 1 extra head.
Side-by-Side type

M-1161
Discussion Bridge with 2 extra heads

M-1162
Discussion Bridge with 4 extra heads

M-1163
Discussion Bridge with 9 extra heads

All Discussion Bridges are equipped with extra heads with WF10x/20mm eyepieces

Application Sets

Koehler DIC transmitted

- M-550** - Interferential green filter IF550.
- M-190P** - Polarizer for transmitted light.
- M-1201** - Analyzer for transmitted light.
- M-1202** - DIC prism for transmitted light.



Usable objective series: **IOS W-PLAN F**, **IOS U-PLAN F**. (See page 168)

Transmitted Koehler DIC combined with Fluo HBO

- M-550** - Interferential green filter IF550.
- M-190P** - Polarizer for transmitted light.
- M-1203** - Analyzer for reflected light.
- M-1202** - DIC prism for transmitted light.



Usable objective series: **IOS W-PLAN F**, **IOS U-PLAN F**. (See page 168)

Nomarski DIC transmitted

- M-1157** - 8-Position universal condenser.
- M-1206** - Top lens 0.9 N.A.
- M-1208** - DIC 10x prism for universal condenser.
- M-1209** - DIC 20x prism for universal condenser.
- M-1210** - DIC 40x/60x prism for universal condenser.
- M-1201** - Analyzer for transmitted light.
- M-1202** - DIC prism for transmitted light.



Usable objective series: **IOS U-PLAN F**, **IOS U-PLAN APO**, **IOS U-PLAN F PH**. (See page 168)

Transmitted Nomarski DIC combined with Fluo HBO

- M-1157** - 8-Position universal condenser.
- M-1206** - Top lens 0.9 N.A.
- M-1208** - DIC 10x prism for universal condenser.
- M-1209** - DIC 20x prism for universal condenser.
- M-1210** - DIC 40x/60x prism for universal condenser.
- M-1203** - Analyzer for reflected light.
- M-1202** - DIC prism for transmitted light.



Usable objective series: **IOS U-PLAN F**, **IOS U-PLAN APO**, **IOS U-PLAN F PH**. (See page 168)

Nomarski DIC reflected for metallurgical appl.

- M-870** - DIC prism for metallurgical reflected light.



Usable objective series: **IOS LWD U-PLAN F MET** Series
IOS LWD U-PLAN F MET BD Series.

See page 168

GOUT analysis kit

- M-1037** - GOUT analysis kit



B-810 - Brightfield & Phase Contrast Microscope

B-810 is the result of the long experience gathered by OPTIKA Microscopes in the field of light microscopy, offering an extremely valuable product for routine and research laboratory brightfield & phase contrast applications.

Ergonomic design for comfortable long-term use and smooth operation with minimal movements meets the concept of modularity, to offer a the possibility to create a tailored version and match all the personal requirements.

It is qualified as an particularly performing and robust solution, considering the field of view of 22 mm, the state-of-the-art, exclusive **X-LED³** lighting source (3.6 W) and the sturdy dye-cast frame for high stability combined with a wide variety of heads, objectives and condensers to get the most out of a microscope.



B-810 - Configuration Chart

Build the microscope that suites your needs by choosing among the components



B-1000BF - Brightfield Microscope

The modular OPTIKA B-1000 helps you working in a comfortable way during extended periods of use and let you perform reliable, accurate and rapid diagnosis benefiting from modularity, which gives the chance to create customized configurations tailored on customer needs.

Versatile, robust, durable and sturdy, B-1000 offers premium quality optics (including Semi-Apo objectives), the state-of-the-art, exclusive **X-LED[®]** (8 W) illumination system, designed by OPTIKA and the Koehler diaphragm. B-1000 gives multiple options as manual or motorized configuration, with the possibility of **ALC** (Automatic Light Control) and a variety of objectives, stages and condensers.



22



24



B-1000BF - Configuration Chart

Build the microscope that suites your needs by choosing among the components

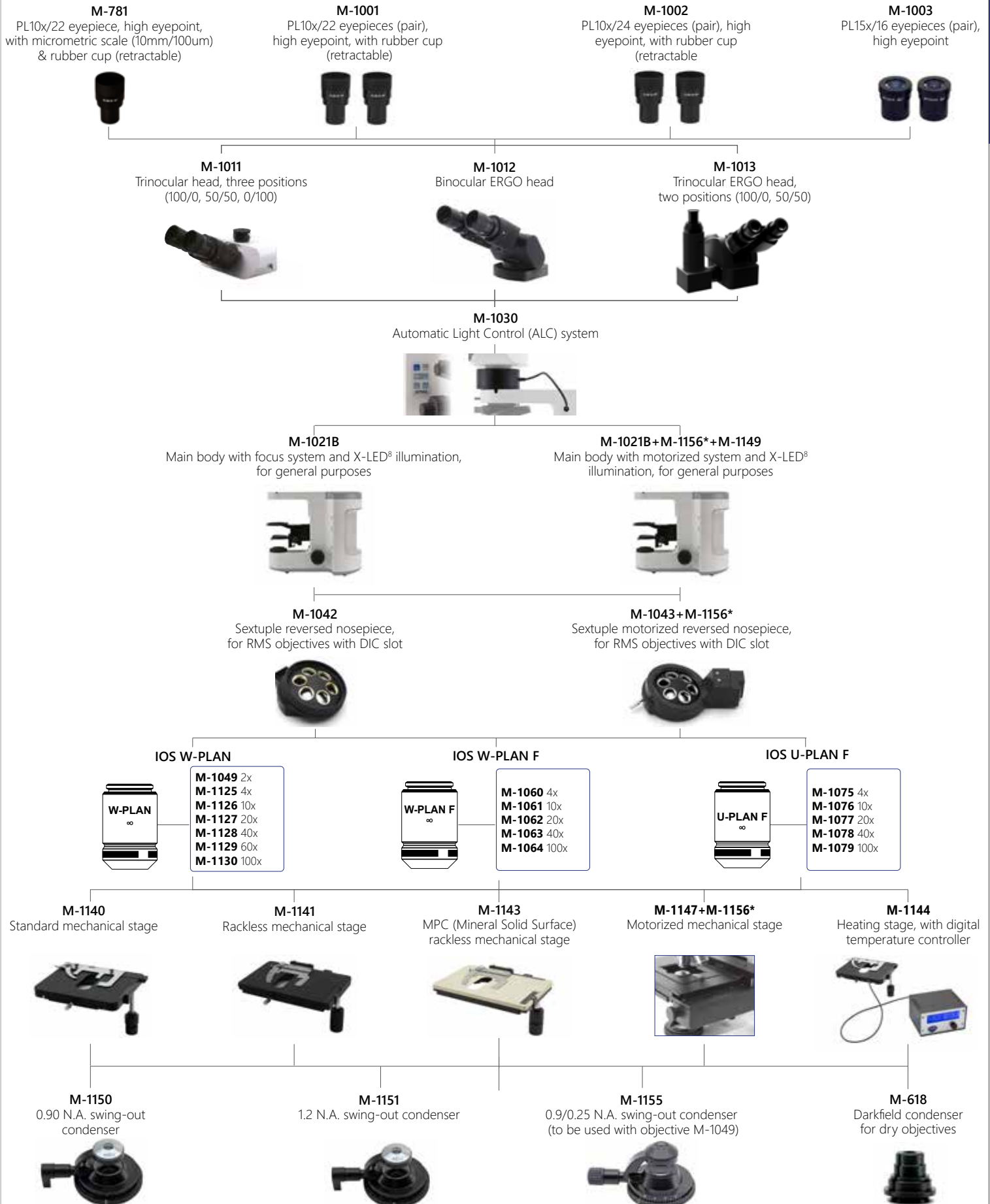

* Code M-1156 must be added only **once** for any motorized configuration

B-1000PH - Phase Contrast Microscope

The modular OPTIKA B-1000 is available in phase contrast and helps you working in a comfortable way during extended periods of use performing reliable, accurate and rapid diagnosis benefiting from modularity, which gives the chance to create customized configurations tailored on customer needs. Versatile, robust, durable and sturdy, B-1000 offers premium quality optics, the state-of-the-art, exclusive **X-LED⁸** (8 W) illumination system, designed by OPTIKA and the Koehler diaphragm. B-1000 gives multiple options as manual or motorized configuration, with the possibility of **ALC** (Automatic Light Control) and a variety of objectives, stages and condensers.



22



24



B-1000PH - Configuration Chart

Build the microscope that suites your needs by choosing among the components



* Code M-1156 must be added only **once** for any motorized configuration

2 B-1000FL-HBO - HBO Fluorescence Microscope

The modular OPTIKA B-1000 can stand a HBO fluorescence attachment, helping you working in a comfortable way during extended periods of use and performing reliable, accurate and rapid diagnosis benefiting from modularity, which gives the chance to create customized configurations tailored on customer needs. Versatile, robust, durable and sturdy, B-1000 offers premium quality optics (including Semi-Apo objectives), the state-of-the-art, exclusive **X-LED⁸** (8 W) illumination system, designed by OPTIKA and the Koehler diaphragm. B-1000 gives multiple options as manual or motorized configuration, with a variety of objectives, stages and condensers.

Standard filterset

Name	Excitation filter (nm)	Dichroic mirror cut-off (nm)	Emission filter (nm)
B Blue	460 - 490	500	520LP
G Green	510 - 550	570	590LP

Additional filterset (optional)

Name	Excitation filter (nm)	Dichroic mirror cut-off (nm)	Emission filter (nm)
V (Violet)	400 - 410	455	455LP
UV	330 - 385	400	420LP



B-1000FL-HBO - Configuration Chart

Build the microscope that suites your needs by choosing among the components



* Code M-1156 must be added only **once** for any motorized configuration

2 B-1000LD4 - LED Fluorescence Microscope

The modular OPTIKA B-1000 can stand a LED fluorescence attachment, helping you working in a comfortable way during extended periods of use and performing reliable, accurate and rapid diagnosis benefiting from modularity, which gives the chance to create customized configurations tailored on customer needs. Versatile, robust, durable and sturdy, B-1000 offers premium quality optics (including Apo and Semi-Apo objectives), the state-of-the-art, exclusive **X-LED³** (8 W) illumination system, designed by OPTIKA and the Koehler diaphragm. B-1000 gives multiple options as manual or motorized configuration, with a variety of objectives, stages and condensers.

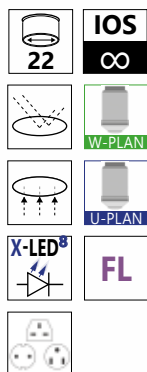

A new milestone achieved in Fluorescence Microscopy

- » Full-modular Fluorescence System
- » Interchangeable LED-Filtersets
- » 4 LED-Filtersets slots
- » 10% higher light intensity than HBO
- » 35% higher light intensity than Metal-Halide
- » Adjustable light intensity
- » The selection of filtersets automatically involves the switching on of the corresponding LEDs
- » Recommended for research applications
- » Cost-effective, money saving technology
- » Ready for immediate operation
- » Eliminate warm-up/cool-down times
- » Forget lamp replacement & centering

LED Fluorescence Cubes available (LED + Filterset)

Name	LED emission (nm)	Excitation filter (nm)	Dichroic mirror cut-off (nm)	Emission filter (nm)
M-1220 - Blue	460	455 - 495	500	510LP
M-1221 - Green	523	510 - 550	570	575LP
M-1222 - Violet	405	390 - 420	440	450LP
M-1223 - UV	365	325 - 375	415	435LP
M-1224 - Red 1	623	590 - 650	660	665LP
M-1225 - Red 2	623	595 - 645	655	665 - 715
M-1226 - Deep Red	660	623 - 678	685	690 - 750
M-1227 - Far Red	740	720 - 760	770	780LP
M-1228 - Amber	590	582 - 603	610	615 - 645

B-1000LD4 - Configuration Chart

Build the microscope that suites your needs by choosing among the components

M-781
PL10x/22 eyepiece, high eyepoint,
with micrometric scale (10mm/100um)
& rubber cup (retractable)



M-1001
PL10x/22 eyepieces (pair),
high eyepoint, with rubber cup
(retractable)



M-1003
PL15x/16 eyepieces (pair),
high eyepoint



M-1011
Trinocular head, three positions
(100/0, 50/50, 0/100)



M-1012
Binocular ERGO head



M-1031M
4-position LED Fluorescence attachment,
without LED Fluorescence Filtersets



M-1220 ... M-1228
LED Fluorescence Cubes
(LED + Filterset)

M-1021B
Main body with focus system and X-LED[®]
illumination, for general purposes



M-1021B+M-1156*+M-1149
Main body with motorized system and X-LED[®]
illumination, for general purposes



M-1042
Sextuple reversed nosepiece,
for RMS objectives with DIC slot



M-1043+M-1156*
Sextuple motorized reversed nosepiece,
for RMS objectives with DIC slot



IOS W-PLAN



M-1049 2x
M-1125 4x
M-1126 10x
M-1127 20x
M-1128 40x
M-1129 60x
M-1130 100x

IOS W-PLAN F



M-1060 4x
M-1061 10x
M-1062 20x
M-1063 40x
M-1064 100x

IOS U-PLAN F



M-1075 4x
M-1076 10x
M-1077 20x
M-1078 40x
M-1079 100x

M-1140
Standard mechanical stage



M-1141
Rackless mechanical stage



M-1143
MPC (Mineral Solid Surface)
rackless mechanical stage



M-1147+M-1156*
Motorized mechanical stage



M-1144
Heating stage, with digital
temperature controller



M-1150
0.90 N.A. swing-out
condenser



M-1151
1.2 N.A. swing-out condenser



M-1155
0.9/0.25 N.A. swing-out condenser
(to be used with objective M-1049)



M-618
Darkfield condenser
for dry objectives



* Code M-1156 must be added only **once** for any motorized configuration

② B-1000POL - Polarizing Microscope

The modular OPTIKA B-1000 is available with transmitted polarized light, helping you working in a comfortable way during extended periods of use and performing reliable, accurate and rapid diagnosis benefiting from modularity, which gives the chance to create customized configurations tailored on customer needs. Versatile, robust, durable and sturdy, B-1000 offers premium quality optics, the state-of-the-art, exclusive **X-LED⁸** (8 W) illumination system, designed by OPTIKA and the Koehler diaphragm.

B-1000 gives multiple options as manual or motorized configuration.



22



24



Dedicated version for transmitted
(**X-LED⁸**, 8 W)
illumination and polarization analysis.

B-1000POL - Configuration Chart

Build the microscope that suites your needs by choosing among the components

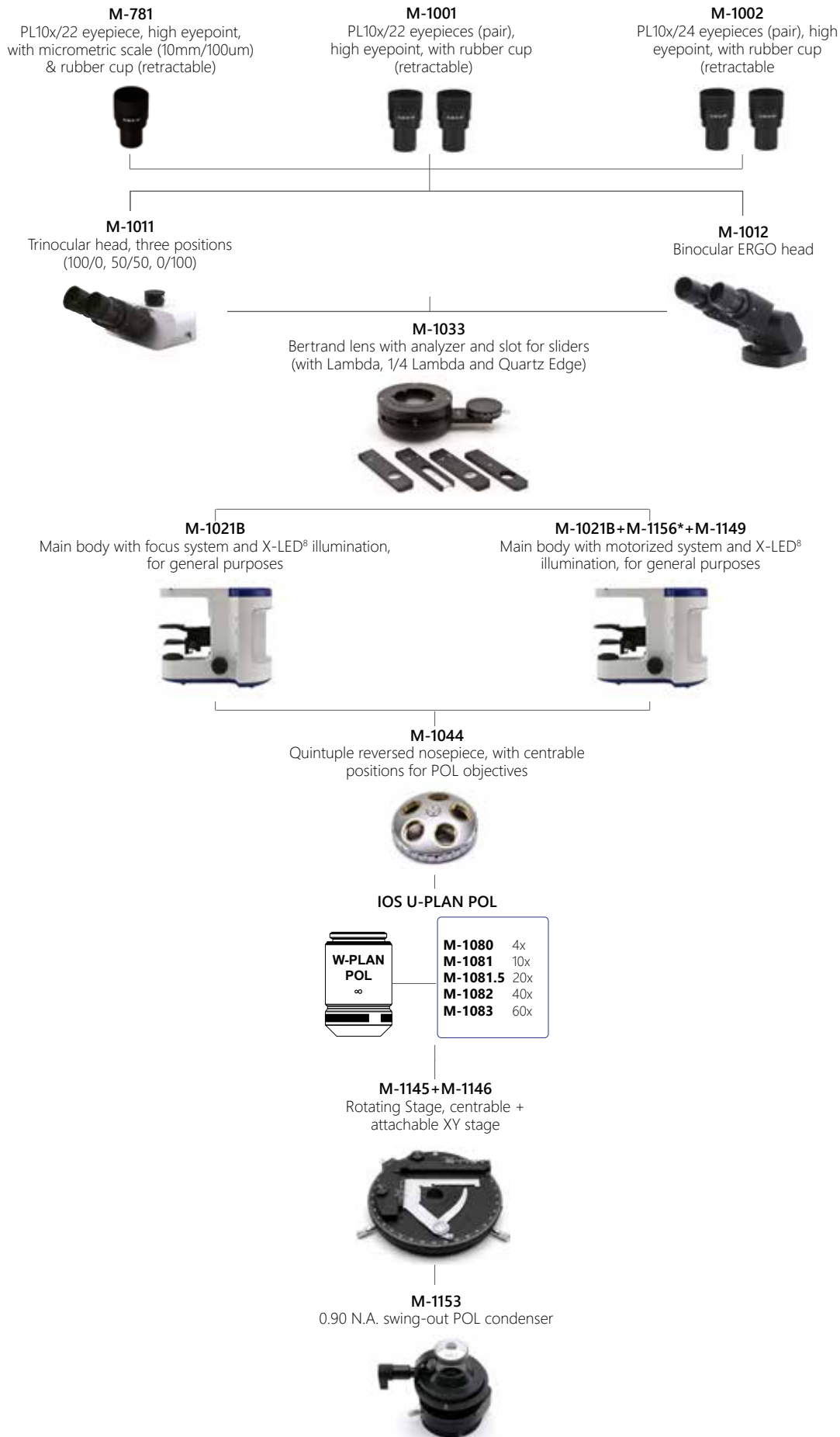

* Code M-1156 must be added only **once** for any motorized configuration

② B-1000POL-I - Polarizing Microscope

The modular OPTIKA B-1000 is available with transmitted and incident polarized light, helping you working in a comfortable way during extended periods of use and performing reliable, accurate and rapid diagnosis benefiting from modularity, which gives the chance to create customized configurations tailored on customer needs. Versatile, robust, durable and sturdy, B-1000 offers premium quality optics, the state-of-the-art, exclusive **X-LED[®]** (8 W) illumination system, designed by OPTIKA and the Koehler diaphragm.

B-1000 gives multiple options as manual or motorized configuration.



Dedicated version for transmitted and incident illumination (**X-LED[®]**, 8 W)



B-1000POL-I - Configuration Chart

Build the microscope that suites your needs by choosing among the components

M-781
PL10x/22 eyepiece, high eyepoint,
with micrometric scale (10mm/100um)
& rubber cup (retractable)



M-1001
PL10x/22 eyepieces (pair),
high eyepoint, with rubber cup
(retractable)



M-1011
Trinocular head, three positions
(100/0, 50/50, 0/100)



M-1012
Binocular ERGO head



M-1033
Bertrand lens with analyzer and slot for sliders
(with Lambda, 1/4 Lambda and Quartz Edge)



M-1034
Incident polarizing attachment



M-1021B
Main body with focus system and X-LED[®] illumination,
for general purposes



M-1021B+M-1156*+M-1149
Main body with motorized system and X-LED[®]
illumination, for general purposes



M-1044
Quintuple reversed nosepiece, with centrable
positions for POL objectives



IOS LWD U-PLAN POL

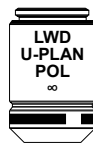

M-1090 5x
M-1091 10x
M-1092 20x
M-1093 50x

M-1145+M-1146
Rotating Stage, centrable +
attachable XY stage



M-1153
0.90 N.A. swing-out POL condenser



* Code M-1156 must be added only **once** for any motorized configuration

B-1000MET - Metallurgical Microscope

The modular OPTIKA B-1000 is available with brightfield and darkfield incident light, helping you working in a comfortable way during extended periods of use and performing reliable, accurate and rapid diagnosis benefiting from modularity, which gives the chance to create customized configurations tailored on customer needs. Versatile, robust, durable and sturdy, B-1000 offers premium quality optics, the state-of-the-art, exclusive **X-LED[®]** (8 W) illumination system, designed by OPTIKA and the Koehler diaphragm. Incident light through 100 W halogen lamp or 18 W LED illumination. B-1000 gives multiple options as manual or motorized configuration.

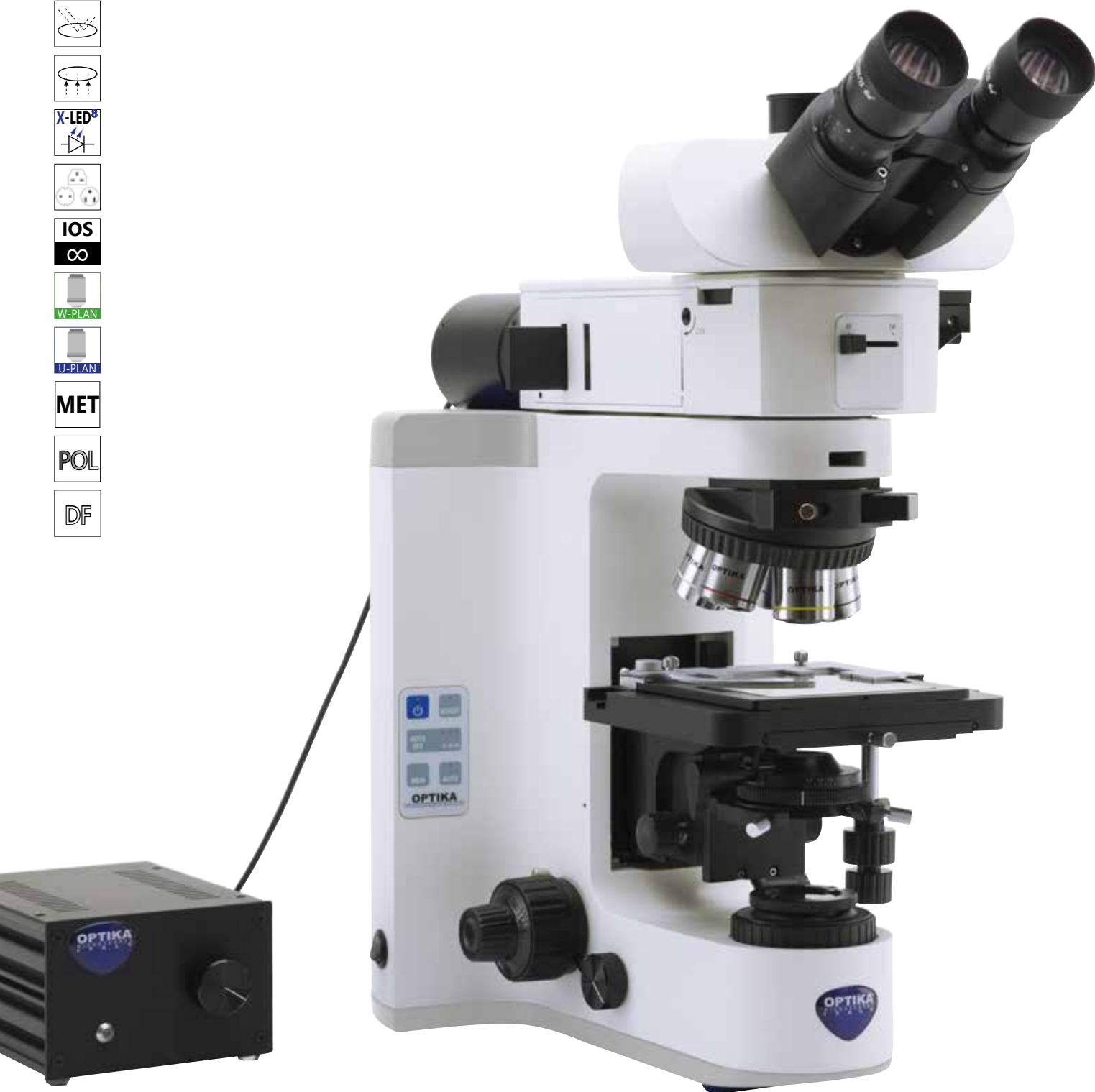

B-1000MET - Configuration Chart

Build the microscope that suites your needs by choosing among the components



* Code M-1156 must be added only **once** for any motorized configuration

B-1000 Multi-Head - Discussion Microscopes

The modular OPTIKA B-1000 helps you working in a comfortable way during extended periods of use and let you perform reliable, accurate and rapid diagnosis benefiting from modularity, which gives the chance to create customized configurations tailored on customer needs.

Versatile, robust, durable and sturdy, B-1000 offers premium quality optics (including Semi-Apo objectives), the state-of-the-art, exclusive **X-LED** illumination system, designed by OPTIKA and the Koehler diaphragm. B-1000 gives multiple options as manual or motorized configuration, with a variety of objectives, stages and condensers. Ideal for discussion groups and teaching purpose for multiple observers, up to ten users simultaneously.

A three-color LED pointer facilitates the indication and identification of the object observed.



B-1000Ti-2 - multi-head microscope for 2 users

B-1000Ti-3 - multi-head microscope for 3 users

B-1000Ti-5 - multi-head microscope for 5 users

B-1000Ti-10 - multi-head microscope for 10 users



B-1000 Multi-Head - Configuration Chart

Build the microscope that suites your needs by choosing among the components

M-781
PL10x/22 eyepiece, high eyepoint, with micrometric scale (10mm/100um) & rubber cup (retractable)



M-1001
PL10x/22 eyepieces (pair), high eyepoint, with rubber cup (retractable)



M-1003
PL15x/16 eyepieces (pair), high eyepoint



M-1011
Trinocular head, three positions (100/0, 50/50, 0/100)



M-1012
Binocular ERGO head



- M-1159** - Multi-head attachment, 1 extra head (face-to-face)
- M-1160** - Multi-head attachment, 1 extra head
- M-1161** - Multi-head attachment, 2 extra head
- M-1162** - Multi-head attachment, 4 extra head
- M-1163** - Multi-head attachment, 9 extra head

M-1021B
Main body with focus system and X-LED[®] illumination, for general purposes



M-1021B+M-1156*+M-1149
Main body with motorized system and X-LED[®] illumination, for general purposes



M-1042
Sextuple reversed nosepiece, for RMS objectives with DIC slot



M-1043+M-1156*
Sextuple motorized reversed nosepiece, for RMS objectives with DIC slot



IOS W-PLAN PH



- M-1120.N** 10x
- M-1121.N** 20x
- M-1122.N** 40x
- M-1123.N** 100x

IOS W-PLAN



- M-1049** 2x
- M-1125** 4x
- M-1126** 10x
- M-1127** 20x
- M-1128** 40x
- M-1129** 60x
- M-1130** 100x

IOS W-PLAN F



- M-1060** 4x
- M-1061** 10x
- M-1062** 20x
- M-1063** 40x
- M-1064** 100x

IOS U-PLAN F



- M-1075** 4x
- M-1076** 10x
- M-1077** 20x
- M-1078** 40x
- M-1079** 100x

M-1140
Standard mechanical stage



M-1141
Rackless mechanical stage



M-1143
MPC (Mineral Solid Surface) rackless mechanical stage



M-1147+M-1156*
Motorized mechanical stage



M-1144
Heating stage, with digital temperature controller



M-1150
0.90 N.A. swing-out condenser



M-1152.N
Phase contrast condenser 10x, 20x, 40x, 100x, BF, DF



M-1124
Phase contrast condenser with insert slide 10x-40x



M-1151
1.2 N.A. swing-out condenser



M-1155
0.9/0.25 N.A. swing-out condenser (to be used with objective M-1049)



M-618
Darkfield condenser for dry objectives



M-977
Green filter, 45mm



* Code M-1156 must be added only **once** for any motorized configuration

B-810/B-1000 - Accessories

Eyecups & Eyepieces

- AA-01 12.5x/18 eyepieces (pair), high eyepoint, focusable, W&B reticle (only for B-810 & B-1000PH)
 M-690 Eyecups (pair)
 M-781 PL10x/22 micrometric eyepiece, high eyepoint, with rubber cup
 M-1001 PL10x/22 eyepieces (pair), high eyepoint, with rubber cup
 M-1002 PL10x/24 eyepieces (pair), high eyepoint, with rubber cup (only for B-1000BF, B-1000PH and B-1000POL)
 M-1003 PL15x/16 eyepieces (pair), high eyepoint (except for B-1000POL & B-1000POL-I)

Condensers & Filters

- M-550 Interferential green filter IF550 (except for B-810, B-1000MET, B-1000POL and B-1000POL-I)
 M-613 Polarizing set (filters only) (except for B-1000FL-LED, B-1000MET, B-1000POL, and B-1000POL-I)
 M-615 Lambda filter for polarizing set (except for B-1000FL-LED, B-1000MET, B-1000POL, and B-1000POL-I)
 M-617.1NO Phase contrast set with IOS W-PLAN objective 40x (only for B-810)
 M-617.1N Phase contrast set with IOS W-PLAN objective 40x (only for B-1000)
 M-975 Blue filter, 45mm diameter (except for B-1000MET)
 M-977 Green filter, 45mm diameter (except for B-1000MET)
 M-979 Yellow filter, 45mm diameter (except for B-1000MET)
 M-989 Frosted glass filter, 45mm diameter (except for B-1000MET)
 M-1164 Empty fluorescence filterblock (only for B-1000FL-HBO)
 M-1165 Fluorescence filter set V (filterblock included) (only for B-1000FL-HBO)
 M-1166 Fluorescence filter set UV-DAPI (filterblock included) (only for B-1000FL-HBO)
 M-ND25 Neutral density filter, 25% transmission (only for B-1000FL-HBO)

Camera Adapters

- M-113.1 Ring adapter, 30mm (for monocular and binocular microscopes)
 M-115 0.35x C-Mount projection lens
 M-114 0.5x C-Mount projection lens
 M-118 0.75x C-Mount projection lens
 M-173 C-Mount projection lens for APS-C/full frame reflex cameras (trino)
 M-620 0.35x focusable C-Mount adapter (biological microscopes)
 M-620.1 0.5x focusable C-Mount adapter (biological microscopes)
 M-620.2 0.65x focusable C-Mount adapter (biological microscopes)
 M-620.3 1x focusable C-Mount adapter (biological & stereomicroscopes)
 M-699 Universal adapter for C-Mount projection lens (trino)

Miscellaneous

- 15008 Immersion oil, 10ml
 15009 Immersion oil, 100ml
 15104 Cleaning kit
 AA-02 HSE-NPL Mark II phase contrast test slide, with certification (only for B-810 & B-1000PH)
 DC-005 TNT dust cover, extra large, 820(l)x550(h) mm
 M-005 Micrometric slide, 26x76mm, with 2 scales (1mm/100 & 10mm/100)
 M-069 Solar charger (only for B-810)
 M-151 HBO 100W high-pressure mercury bulb for fluorescence
 M-151.1 HBO 100W high-pressure mercury bulb for fluorescence (OSRAM)
 M-1004.N Centering telescope, 30mm diameter (only for B-810, B-1000PH and B-1000TI Series)
 M-1073 Gout analysis kit
 VP-1000 IQ/OQ/PQ manual for B-1000 series (Brightfield)
 VP-1000MET IQ/OQ/PQ manual for B-1000 series (Metallographic)
 VP-1000POL IQ/OQ/PQ manual for B-1000 series (Polarizing)
 VP-810 IQ/OQ/PQ manual for B-810 series
 VP-1000PH IQ/OQ/PQ manual for B-1000 series (Phase Contrast)
 VP-1000FL IQ/OQ/PQ manual for B-1000 series (Fluorescence)

M-069 - Solar charger

Included battery: rechargeable – Lithium-Poly.
 Capacity: 2500 mAh. - Output voltage: 5 Vdc.
 Autonomy: over 6 hours at medium intensity (X-LED³).
 Charging models: with solar panel (12h),
 with external USB power supply (2.5h)



15104 - Cleaning kit

It cleans glass quickly and effectively,
 without leaving residue or odor.
 Ideal for precision lens or prism cleaning.



How to connect the cameras to our microscopes.

Please refer to the Adapter reference list on Digital section.

v 2.1.0 - OPTIKA reserves the right to make corrections, modifications, enhancements, improvements and other changes to its products at any time without notice.

Headquarters and Manufacturing Facilities

OPTIKA® S.r.l. Via Rigla, 30 - 24010 Ponteranica (BG) - ITALY - Tel.: +39 035.571.392 - info@optikamicroscopes.com

Optika Sales branches

OPTIKA® Spain spain@optikamicroscopes.com
OPTIKA® China china@optikamicroscopes.com
OPTIKA® India india@optikamicroscopes.com

OPTIKA® USA usa@optikamicroscopes.com
OPTIKA® Central America camerica@optikamicroscopes.com