

CUT 4050, 4055 and 4060 - Specification

		Performance		4050	4050 F	4055	4055 F	4060	4060 F
Range of section thickness	from 0,5 µm to 60 µm	X	X	X	X	X	X	X	X
Increments	0,5 µm from 0,5 µm to 2 µm								
	1 µm from 2 µm to 10 µm	X	X	X	X	X	X	X	X
	2 µm from 10 µm to 20 µm								
	5 µm from 20 µm to 60 µm								
Horizontal Specimen Advance	40 mm	X	X	X	X	X	X	X	X
Vertical Stroke	70 mm	X	X	X	X	X	X	X	X
Specimen Size	Standard maximum 55 mm x 55 mm	X	X	X	X	X	X	X	X
Handwheel Locking integrated in the Handwheel		X	X	X	X	X	X	X	X
Coarse Advance	- Handwheel - left side								
	- Adjustment optional clockwise counterclockwise	X		X		X		X	
Coarse Advance	Frontpositioned handwheel		X		X			X	X
Specimen Retraction	on return stroke approx. 80 µm			X	X	X	X	X	X
Section Counter	4 digits LCD read-out							X	X
Auto-Trim in 3 steps	Trimlevel 1:10 µm Trimlevel 2:20 µm Trimlevel 3:30 µm							X	X
Dimensions	length x width x height: 460 mm x 460 mm x 280 mm								
Weight	36 kg (without accessories)								

(Specifications are subject to change without notice)



Connect With Us



microTec[®] ROTARY MICROTOME CUT 4050 / 4055 / 4060



...Modular system with exceptional precision

The **microTec** - rotary microtome series 4050 / 4055 / 4060 are designed as a modular system.

Whether knife-holders or specimen holders - a rational adapter system and different accessories make the use of CUT 4050, CUT 4055 and CUT 4060 child's play. Rapid knife-change and exchanging of specimen supports is effected without loss of the basic adjustment.

microTec - the name of precision

microTec PRECISION-MECHANICS OF THE HIGHEST QUALITY

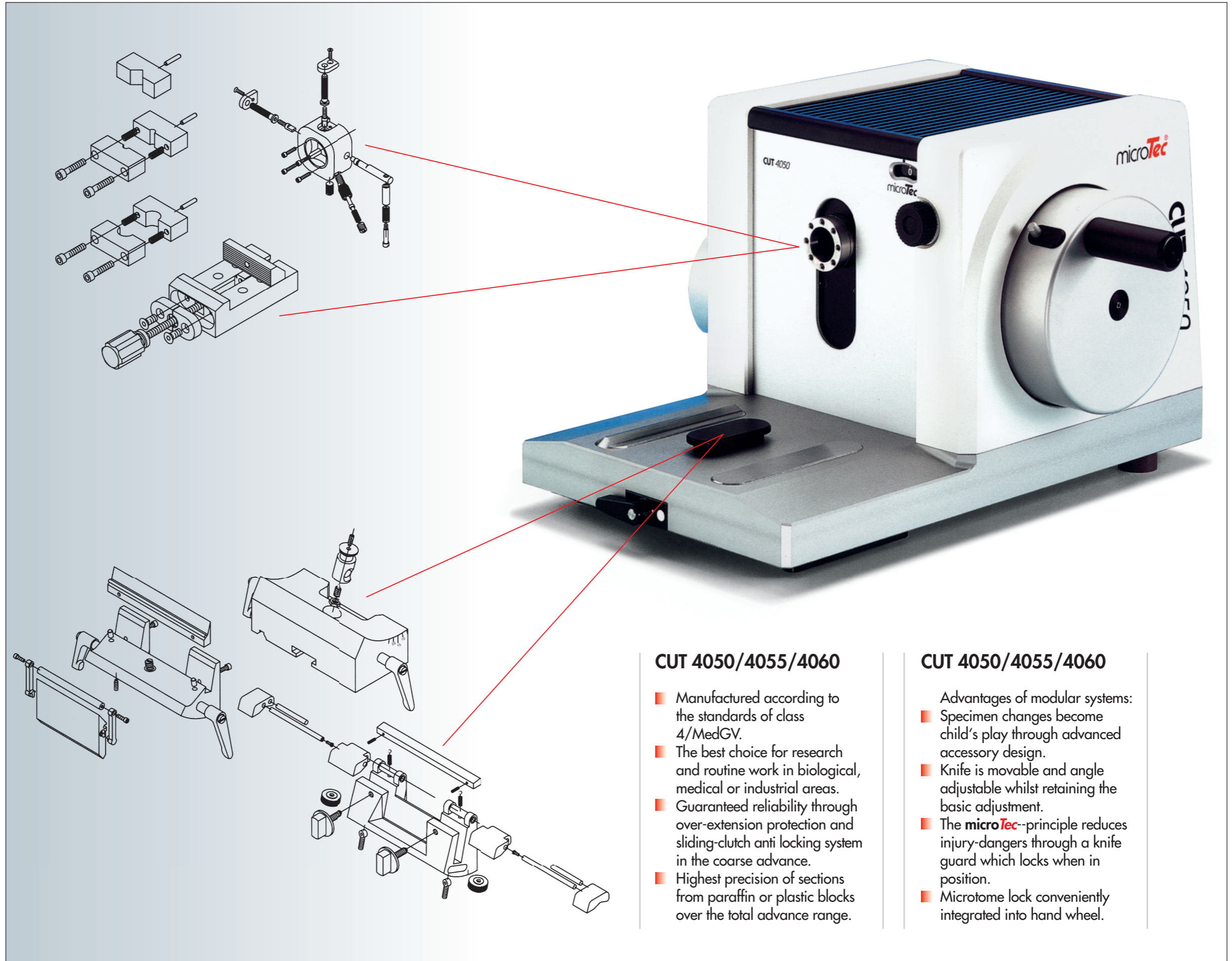
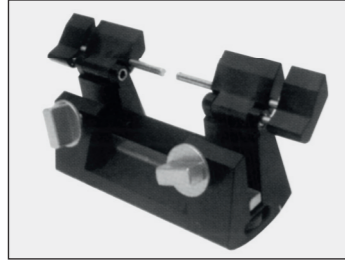
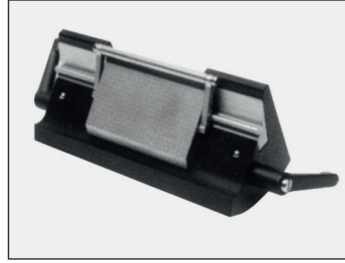
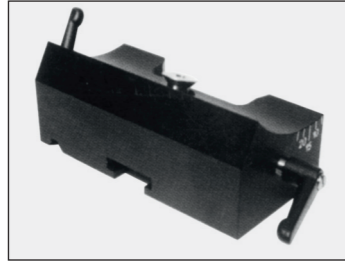
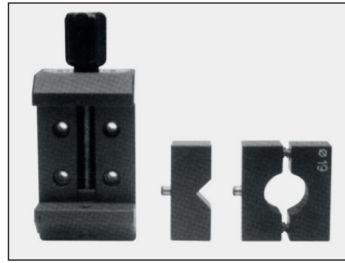
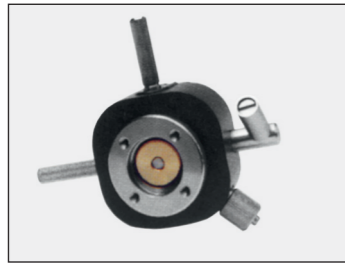
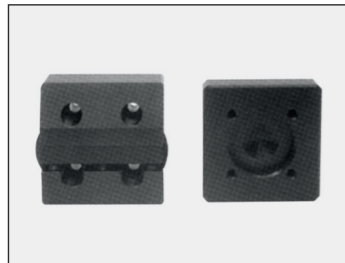

CUT 4050/4055/4060

- Manufactured according to the standards of class 4/MedGV.
- The best choice for research and routine work in biological, medical or industrial areas.
- Guaranteed reliability through over-extension protection and sliding-clutch anti locking system in the coarse advance.
- Highest precision of sections from paraffin or plastic blocks over the total advance range.

CUT 4050/4055/4060

- Advantages of modular systems:
- Specimen changes become child's play through advanced accessory design.
 - Knife is movable and angle adjustable whilst retaining the basic adjustment.
 - The **microTec**-principle reduces injury-dangers through a knife guard which locks when in position.
 - Microtome lock conveniently integrated into hand wheel.